

## CONFUSIONE SUSPENSION

### D131000

base number

- To build a product code in our configurator select the specify button on the base model # product page
- To build a manual product code on this datasheet choose from the options listed below in blue font and add the suffix to the base model #

#### GENERAL

Series: Confusione  
 Brand: Knikerboker  
 Division: Design  
 Mounting Type: Suspension  
 Mounting Location: Ceiling  
 Subcategory: Ambient

#### PHYSICAL

Shape: Curves  
 Diameter (mm): 750  
 Diameter (in): 29 1/2  
 Height (mm): 1500  
 Height (in): 59 1/16  
 Max. Overall Height (mm): 1500  
 Max. Overall Height (in): 59 1/16  
 Light Distribution: Direct / Indirect  
 Fixture Finish: ANA  
 Fixture Material: Anodized Aluminum  
 Cable Details: 3 Steel Cable 2000mm

#### ELECTRICAL

Number of Lamps: 10  
 Lamp Type: LED  
 Bulb Included: Bulb Included  
 Total Output Wattage (W): 10  
 Max. Wattage Per Lamp (W): 1  
 Lamp Base: G4  
 Dimming: Non-Dimmable  
 Driver Included: Yes  
 Driver Location: Integrated  
 Driver Type: Constant Voltage - 120Vac  
 Driver Class: Class 2  
 Input Voltage (V): 120 - 277  
 Output Voltage (V): 12  
 Lamp Voltage (V): 12  
 Upon Request: (Not included - see components) Remote: 0-10Vdc dimming / Phase dimming @120Vac only / 277Vac

#### LED

Number of LEDs: 10  
 Color Temperature (°K): 3000  
 Max. Delivered Lumen (lm): 800  
 CRI: >80 CRI

#### OPTICAL

#### RATINGS AND CERTIFICATIONS

Certified By: Certified for North American Standards  
 IP rating: IP20

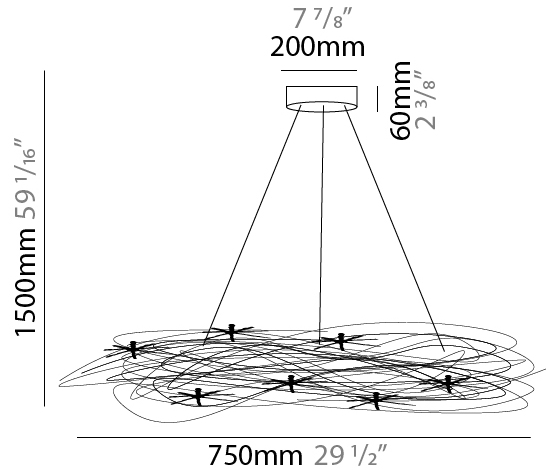

## CONFUSIONE SUSPENSION

D131000

PROJECT

TYPE

SPECIFIER

QUANTITY

DATE



D

## CONFUSIONE SURFACE

**D133009**

base number

- To build a product code in our configurator select the specify button on the base model # product page
- To build a manual product code on this datasheet choose from the options listed below in blue font and add the suffix to the base model #

### GENERAL

Series: Confusione  
 Brand: Knikerboker  
 Division: Design  
 Mounting Type: Surface  
 Mounting Location: Wall  
 Subcategory: Ambient

### PHYSICAL

Shape: Abstract  
 Diameter (mm): 500  
 Diameter (in): 19 <sup>11</sup>/<sub>16</sub>"  
 Height (mm): 500  
 Height (in): 19 <sup>11</sup>/<sub>16</sub>"  
 Light Distribution: Direct / Indirect  
 Fixture Finish: ANA  
 Fixture Material: Aluminum

### ELECTRICAL

Number of Lamps: 10  
 Lamp Type: LED  
 Input Wattage (W): 12  
 Bulb Included: Bulb Included  
 Total Output Wattage (W): 10  
 Max. Wattage Per Lamp (W): 1  
 Lamp Base: G4  
 Dimming: Non-Dimmable  
 Driver Included: Yes  
 Driver Location: Integrated  
 Driver Type: Constant Voltage - Universal  
 Driver Class: Class 2  
 Input Voltage (V): 120 - 277  
 Output Voltage (V): 12  
 Upon Request: Remote: 0-10Vdc dimming / Phase dimming @120Vac only

### LED

Number of LEDs: 10  
 Color Temperature (°K): 3000  
 Max. Delivered Lumen (lm): 800  
 CRI: >80 CRI

### OPTICAL

### RATINGS AND CERTIFICATIONS

Certified By: Certified for North American Standards  
 IP rating: IP20

PROJECT
TYPE
SPECIFIER
QUANTITY
DATE

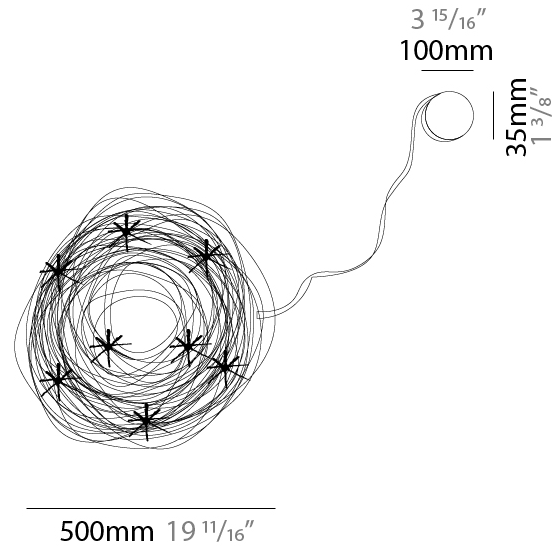

D133009

PROJECT	_____
TYPE	_____
SPECIFIER	_____
QUANTITY	_____
DATE	_____

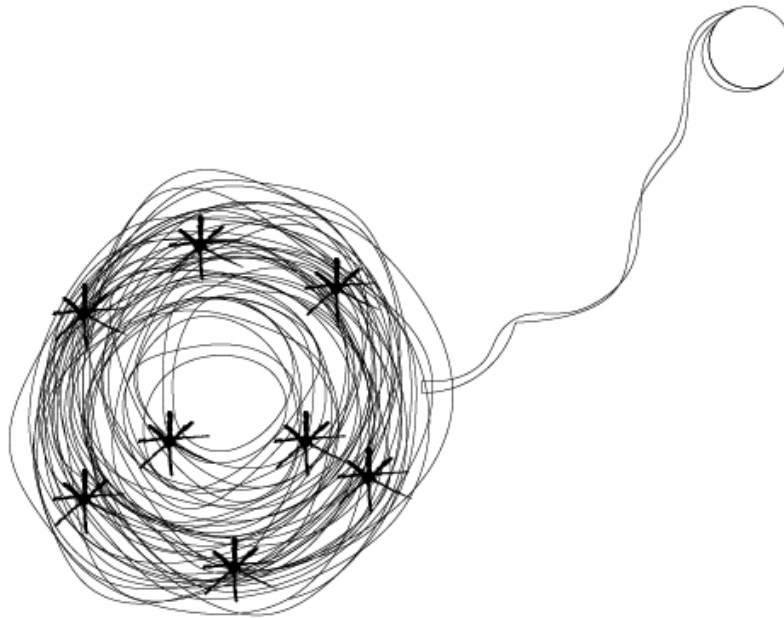

PROJECT
TYPE
SPECIFIER
QUANTITY
DATE

## CONFUSIONE PORTABLE

**D134048**

base number

- To build a product code in our configurator select the specify button on the base model # product page
- To build a manual product code on this datasheet choose from the options listed below in blue font and add the suffix to the base model #

### GENERAL

Series: Confusione  
 Brand: Knikerboker  
 Division: Design  
 Mounting Type: Portable  
 Mounting Location: Floor  
 Subcategory: Floor

### PHYSICAL

Shape: Curves  
 Length (mm): 1400  
 Length (in): 55 1/8  
 Width (mm): 300  
 Width (in): 11 13/16  
 Height (mm): 1800  
 Height (in): 70 7/8  
 Light Distribution: Direct / Indirect  
 Fixture Finish: ANA  
 Fixture Material: Anodized Aluminum  
 Cable Details: Anodized Aluminum Wire 1400mm / 55 1/8"  
 Upon Request: Bolt Down

### ELECTRICAL

Number of Lamps: 40  
 Lamp Type: LED  
 Input Wattage (W): 48  
 Bulb Included: Bulb Included  
 Total Output Wattage (W): 40  
 Max. Wattage Per Lamp (W): 1  
 Lamp Base: G4  
 Dimming: Non-Dimmable  
 Driver Included: Yes  
 Driver Location: Integrated  
 Driver Type: Constant Voltage - Universal  
 Driver Class: Class 2  
 Input Voltage (V): 120 - 277  
 Output Voltage (V): 12  
 Lamp Voltage (V): 12  
 Upon Request: Integral Non-dimming 277Vac

### LED

Color Temperature (°K): 3000  
 Max. Delivered Lumen (lm): 3200  
 CRI: >80 CRI

### OPTICAL

### RATINGS AND CERTIFICATIONS

Certified By: Certified for North American Standards  
 IP rating: IP20

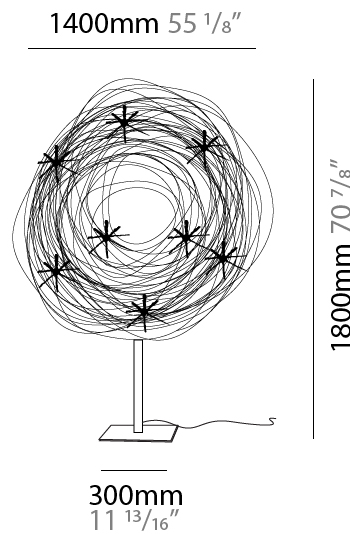

## CONFUSIONE PORTABLE

D134048

PROJECT

TYPE

SPECIFIER

QUANTITY

DATE

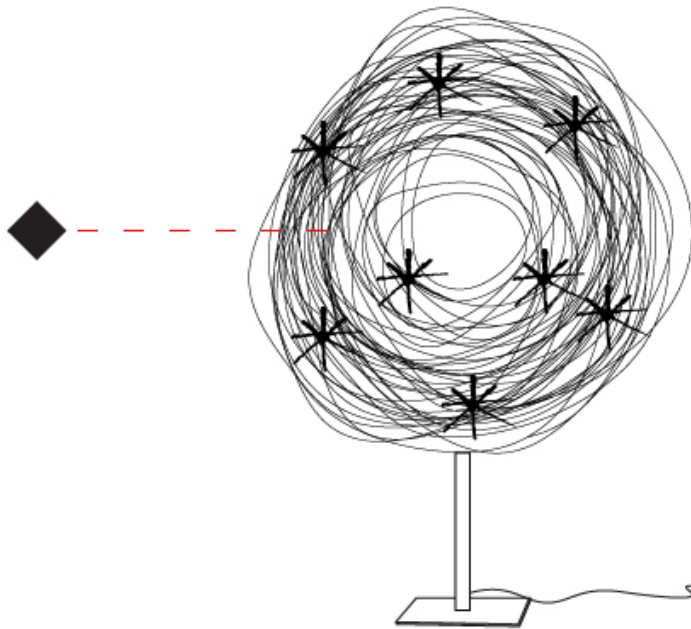

D

## CONFUSIONE PORTABLE

**D134049**

base number

- To build a product code in our configurator select the specify button on the base model # product page
- To build a manual product code on this datasheet choose from the options listed below in blue font and add the suffix to the base model #

### GENERAL

Series: Confusione  
 Brand: Knikerboker  
 Division: Design  
 Mounting Type: Portable  
 Mounting Location: Floor  
 Subcategory: Floor

### PHYSICAL

Shape: Curves  
 Length (mm): 2000  
 Length (in): 78 3/4  
 Width (mm): 300  
 Width (in): 11 13/16  
 Height (mm): 2400  
 Height (in): 94 1/2  
 Light Distribution: Direct / Indirect  
 Fixture Finish: ANA  
 Fixture Material: Anodized Aluminum  
 Upon Request: Bolt Down

### ELECTRICAL

Number of Lamps: 50  
 Lamp Type: LED  
 Input Wattage (W): 60  
 Bulb Included: Bulb Included  
 Total Output Wattage (W): 50  
 Max. Wattage Per Lamp (W): 1  
 Lamp Base: G4  
 Dimming: Non-Dimmable  
 Driver Included: Yes  
 Driver Location: Integrated  
 Driver Type: Constant Voltage - Universal  
 Driver Class: Class 2  
 Input Voltage (V): 120 - 277  
 Output Voltage (V): 12  
 Lamp Voltage (V): 12  
 Upon Request: Integral Non-dimming 277Vac

### LED

Color Temperature (°K): 3000  
 Max. Delivered Lumen (lm): 4000  
 CRI: >80 CRI

### OPTICAL

### RATINGS AND CERTIFICATIONS

Certified By: Certified for North American Standards  
 IP rating: IP20

PROJECT
TYPE
SPECIFIER
QUANTITY
DATE

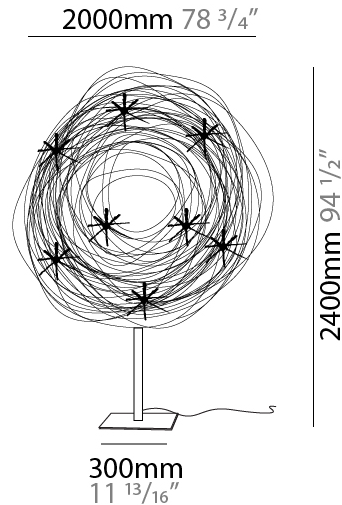

## CONFUSIONE PORTABLE

D134049

PROJECT

TYPE

SPECIFIER

QUANTITY

DATE

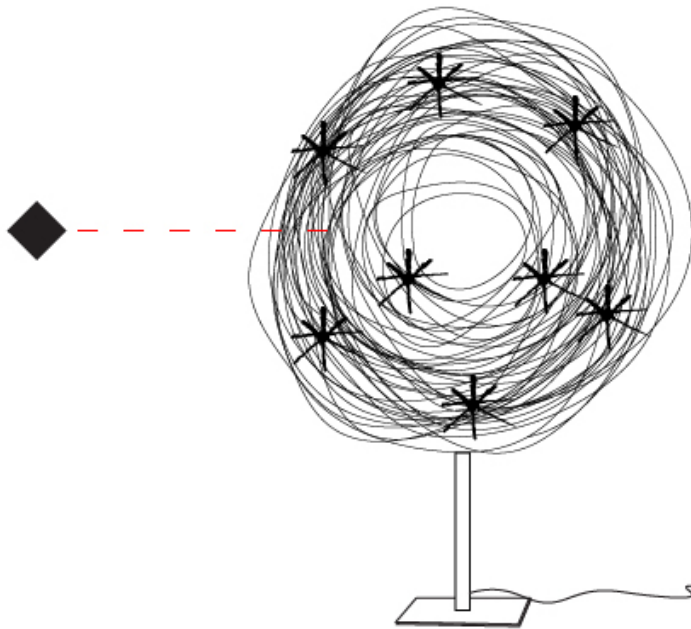

D



PROJECT

TYPE

SPECIFIER

QUANTITY

DATE

### Fixture Finish

Aluminum Natural Anodized - ANA



**Digital:** Not all screens are calibrated the same, and therefore, colors will appear differently between screens.

**Physical:** When texture is involved, there will be variations in color, character and tone within a product series and between product families.



PROJECT	
TYPE	
SPECIFIER	
QUANTITY	
DATE	

### LEGEND

floor-mounted	pivotal	special LED (upon request) RGB, RGBW, tunable, gold+, meat+, art+, fashion+
wall and ceiling: recessed and surface mounted	rotating	warm dim / natural dimming LED
ceiling-mounted and wall-mounted	illuminate tilted	rechargeable battery powered
wall-mounted	color of suspension cable	fixture with natural vivid LED (upon request)
omni-directional light distribution	length of suspension cable	color rendering index
direct light distribution	reflector degree selection	color temperature
direct/indirect light distribution	super spot	lumen (luminous flux)
indirect light distribution	lens	efficacy (lumens per watt)
asymmetric light distribution	lens pack	Unified Glare Rating (UGR) range from 5-40
aura light distribution	shine ring	marine grade (AISI 316 stainless steel)
round wall or ceiling cut-out	integrated shine ring with diffuser	walk on
square wall or ceiling cut-out	free individual colors 01-29	drive on
the supplied jig specifies the cutout dimensions	individual colors: 00 (free of charge), 01-25 (extra charge)	Dark Sky Compliance
minimum distance (meters) lamp - object	luminaire part to be colored (F1)	Americans with Disabilities Act (less than 4" off the wall located between 27"-84" from floor)
recessed depth	luminaire part to be colored (F2)	lamp protected against explosion
ceiling thickness in mm	luminaire part to be colored (F3)	blown glass using traditional methods by master glass blower
ceiling thickness selection	luminaire part to be colored (F4)	acoustic material
dimmable DP (phase), DV (0-10V), DD (dali), DS (step-dim)	luminaire part to be colored (F5)	protection class I, protection insulation
included or excluded LED driver/transformer/control gear	color of 3-circuit adaptor	protection class II, protection insulation
separately switchable	indirect diffuser	ETL Certified to UL and CSA Standards
sensor	direct diffuser	UL Certified to UL and CSA Standards
remote control	ball-proof (upon request)	CSA Certified to UL and CSA Standards
available upon request	accessory	Certified for North American Standards

### IP RATING

IP20	protected against ingress of solid bodies greater than 12.5mm (finger)
IP33	protected against ingress of solid bodies greater than 2.5mm protected against sprays of water up to 60 degrees from the vertical (rain)
IP40	protected against ingress of solid bodies greater than 1mm (wire) no protection against the ingress of moisture
IP43	protected against ingress of solid bodies greater than 1mm (wire) protected against sprays of water up to 60 degrees from the vertical (rain)
IP44	protected against ingress of solid bodies greater than 1mm (wire) protected against water splashed from all directions
IP54	protected against limited ingress of dust (wet rooms/covered outdoor areas) protected against water splashed from all directions
IP65	protected against ingress of dust protected against jets of water
IP66	protected against ingress of dust protected against powerful jets of water or heavy seas
IP67	protected against ingress of dust protected against immersion of water between 15cm - 1m for 30 minutes
IP68	protected against ingress of dust protected against immersion of water under pressure for long periods

### IK RATING

IK01	protected against 0.14 joules impact (equivalent to 0.25kg mass dropped from 56mm above the surface)
IK02	protected against 0.2 joules impact (equivalent to 0.25kg mass dropped from 80mm above the surface)
IK03	protected against 0.35 joules impact (equivalent to 0.25kg mass dropped from 140mm above the surface)
IK04	protected against 0.5 joules impact (equivalent to 0.25kg mass dropped from 200mm above the surface)
IK05	protected against 0.7 joules impact (equivalent to 0.25kg mass dropped from 280mm above the surface)
IK06	protected against 1 joules impact (equivalent to 0.25kg mass dropped from 400mm above the surface)
IK07	protected against 2 joules impact (equivalent to 0.5kg mass dropped from 400mm above the surface)
IK08	protected against 5 joules impact (equivalent to 1.7kg mass dropped from 300mm above the surface)
IK09	protected against 10 joules impact (equivalent to 5.0kg mass dropped from 200mm above the surface)
IK10	protected against 20 joules impact (equivalent to 5.0kg mass dropped from 400mm above the surface)